

Technical Data Sheet

High Power Infrared LED

IR-C19D-N90/L562-P03/TR



Features

- Small package with high efficiency
- Peak wavelength $\lambda_p=940\text{nm}$
- Soldering methods:SMT
- Thermal resistance (junction to lead): $11^\circ\text{C}/\text{W}$.
- Pb free
- Compliance with EU REACH
- Compliance Halogen Free(Br < 900ppm, Cl < 900ppm, Br+Cl < 1500ppm)
- The product itself will remain within RoHS compliant version.

Descriptions

- IR-C19D-N90/L562-P03/TR series is an infrared emitting diode in miniature SMD package which is molded in a water clear silicone with spherical top view lens.
- The device is spectrally matched with silicon photodiode, Phototransistor.

Applications

- CCD Camera
- Infrared applied system

Package Dimensions

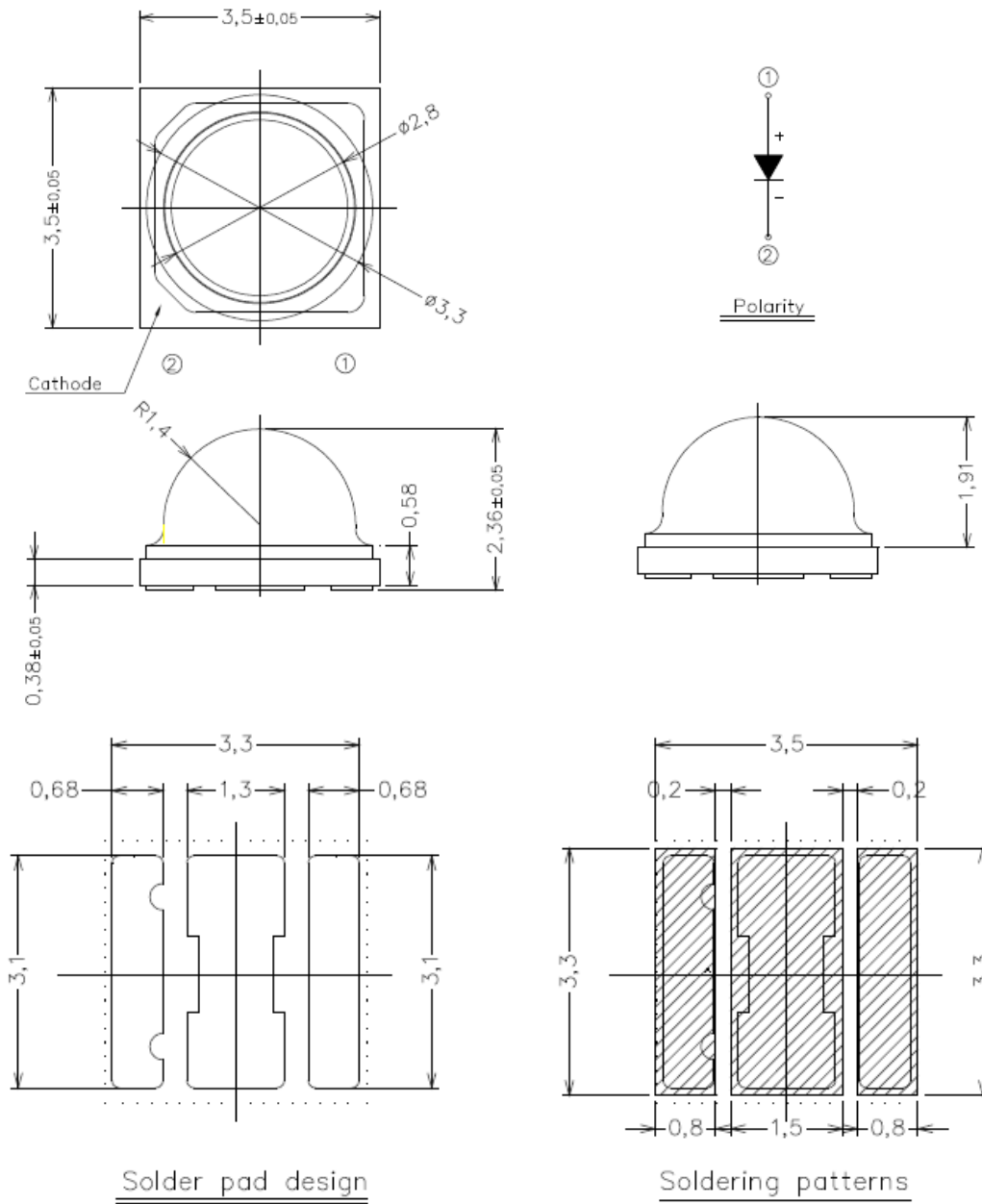

1. Dimensions are in millimeters.
2. Tolerances unless mentioned are ± 0.1 mm.
3. Do not handle the device by the lens. Incorrect force applied to the lens may lead to the failure of devices.

Pad Configuration

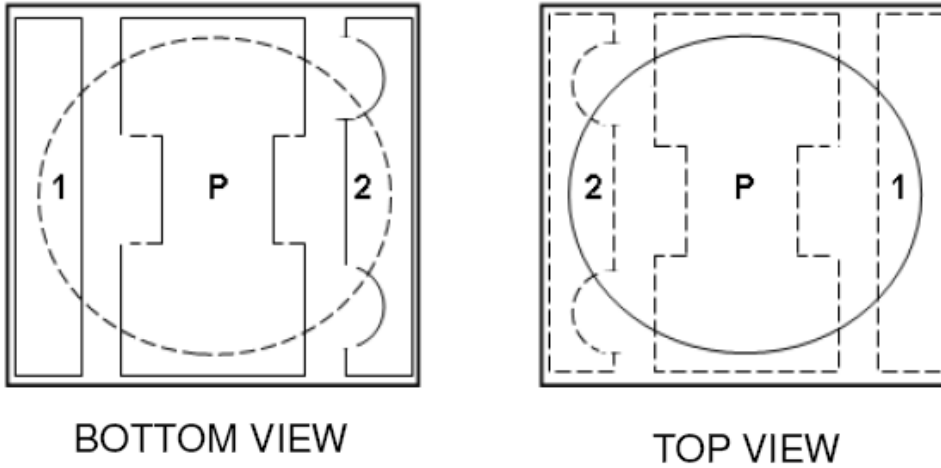

PAD	FUNCTION
1	ANODE
2	CATHODE
P	THERMAL PAD

Absolute Maximum Ratings (Ta=25°C)

Parameter	Symbol	Rating	Unit
Forward Current	I_F	1	A
Reverse Voltage	V_R	5	V
Operating Temperature	T_{opr}	-40 ~ +125	°C
Storage Temperature	T_{stg}	-40 ~ +125	°C
Junction temperature	T_j	115	°C
Thermal resistance (junction to leadframe)	$R_{th(j-L)}$	11	°C/W
Power Dissipation @ $I_F=1000mA$	P_d	3.7	W

Note: We suggest that customer should add the heat sink with IR-C19D-N90/L562-P03/TR to exclude the heat.

Electro-Optical Characteristics (Ta=25°C)

Parameter	Symbol	Condition	Min.	Typ.	Max.	Unit
Total Radiated Power	Po	IF=350mA	--	370	--	mW
		IF=700mA	--	740	--	
		IF=1A	--	1070	--	
Radiant Intensity	IE	IF=350mA	150	170	--	mW/sr
		IF=700mA	330	350	--	
		IF=1A	450	470	--	
Peak Wavelength	λ_p	IF=350mA	--	940	--	nm
Spectral Bandwidth	$\Delta\lambda$	IF=350mA	--	25	--	nm
Forward Voltage	VF	IF=350mA	--	3.1	--	V
		IF=700mA	--	3.4	--	
		IF=1A	--	3.7	--	
Reverse Current	IR	VR=5V	--	--	10	μ A
View Angle	2 θ 1/2	IF=20mA	--	90	--	deg

Typical Electro-Optical Characteristics Curves

Fig.1 Ambient Temperature vs Forward Current

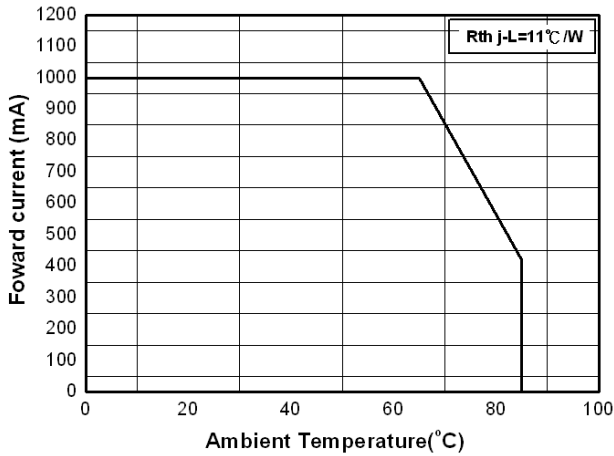

Fig.2 Forward Current vs. Forward Voltage

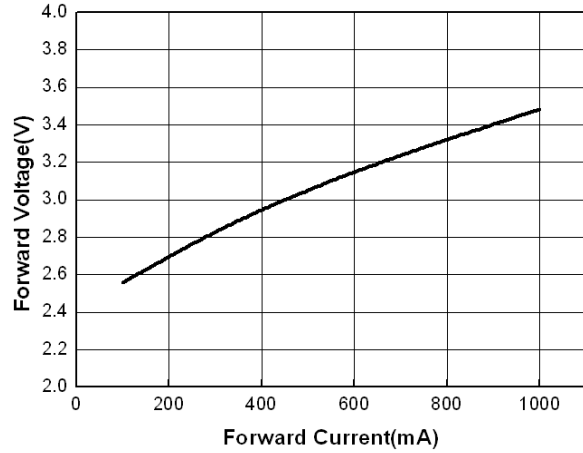

Fig.3 Angular Displacement Relative Radiant Intensity

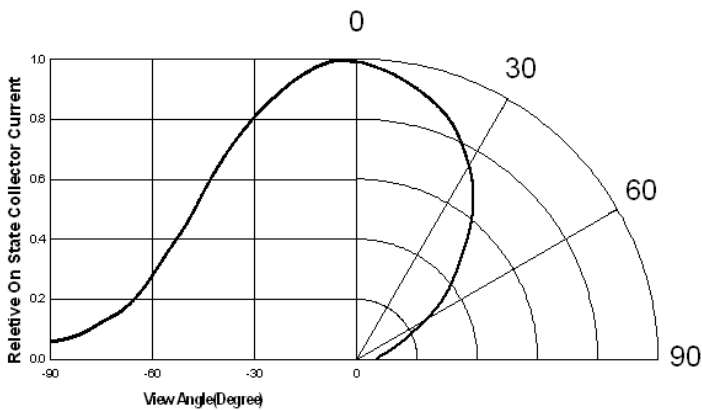

Fig.4 Spectral Distribution

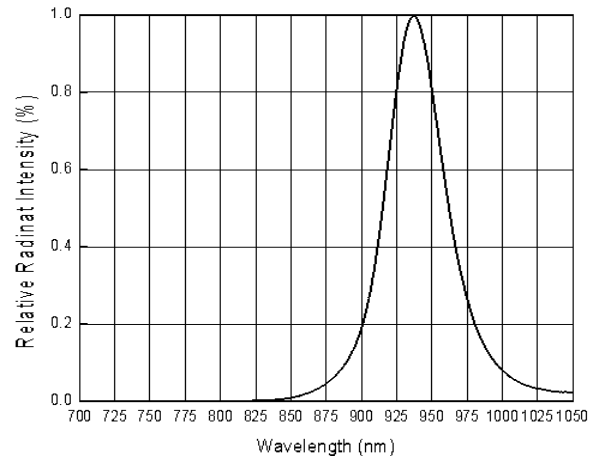
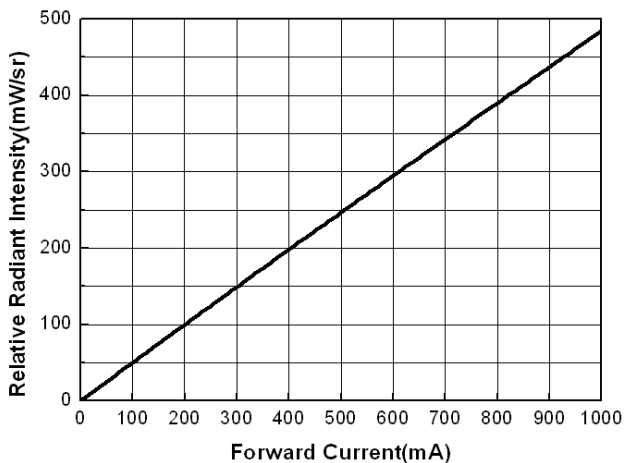

Fig.5 Forward Current vs. Radiant Intensity



Reflow Soldering Characteristics

For Reflow Process

1. C19D series are suitable for SMT processes.
2. Curing of glue in oven must be according to standard operation flow processes.

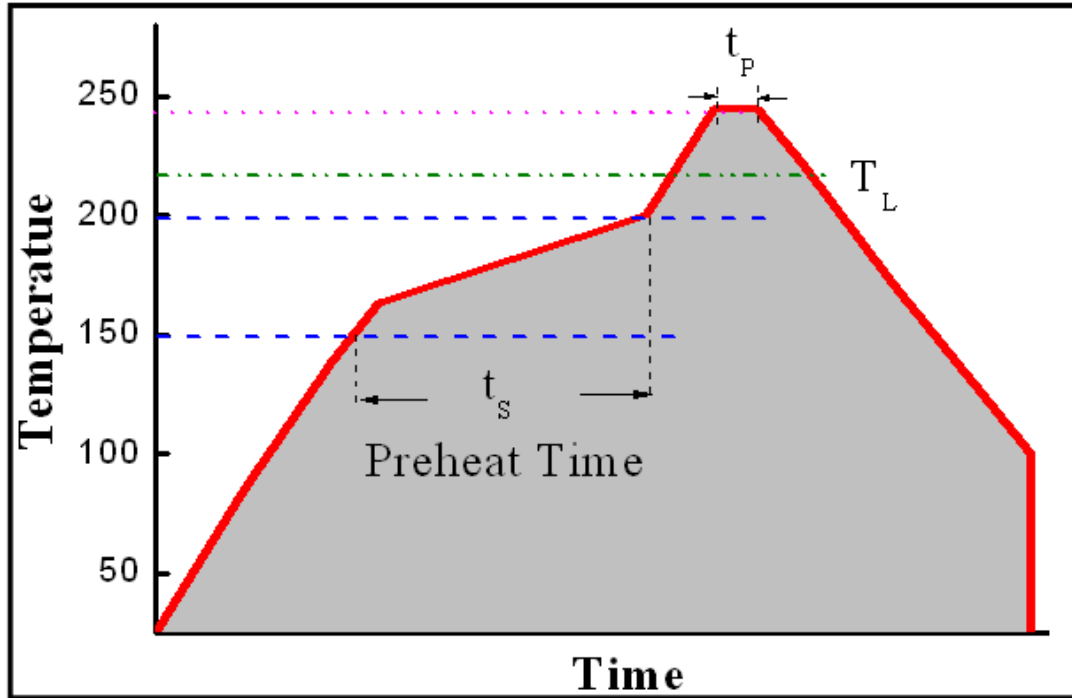

Profile Feature	Lead Free Assembly
Ramp-Up Rate	2-3 °C/S
Preheat Temperature	150-200 °C
Preheat Time (t_s)	60-120 S
Liquid Temperature (T_L)	217 °C
Time maintained above T_L	60-90 S
Peak Temperature (T_P)	240±5 °C
Peak Time (t_p)	Max 20 S
Ramp-Down Rate	3-5 °C/S

3. Reflow soldering should not be done more than twice.
4. In soldering process, stress on the LEDs during heating should be avoided.

Moisture Resistant Packaging

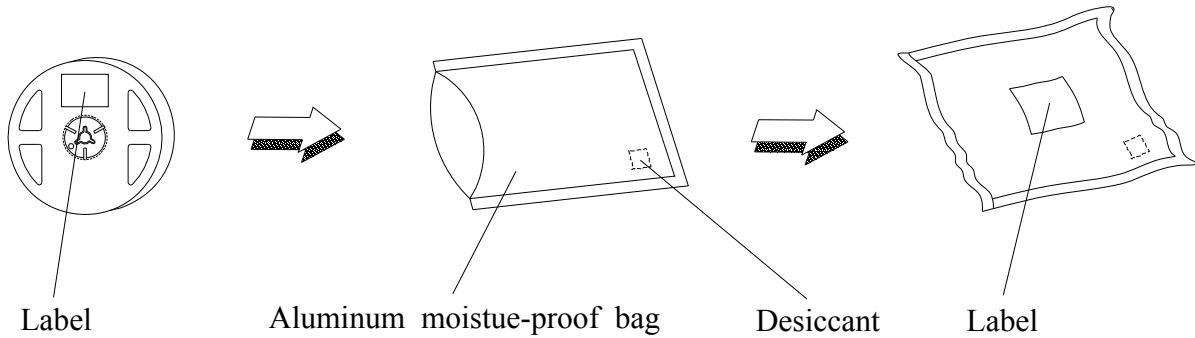

Label Form Specification



CPN: Customer's Production Number

P/N : Production Number

QTY: Packing Quantity

CAT: Ranks

HUE: Peak Wavelength

REF: Reference

LOT No: Lot Number

MADE IN TAIWAN: Production Place

EVERLIGHT ELECTRONICS CO., LTD.
Office: No. 6-8, Zhonghua Rd., Shulin Dist.
New Taipei City 23860, Taiwan, R.O.C

Tel: 886-2-2685-6688
Fax: 886-2-2685-6897
<http://www.everlight.com>

DISCLAIMER

1. EVERLIGHT reserves the right(s) on the adjustment of product material mix for the specification.
2. The product meets EVERLIGHT published specification for a period of twelve (12) months from date of shipment.
3. The graphs shown in this datasheet are representing typical data only and do not show guaranteed values.
4. When using this product, please observe the absolute maximum ratings and the instructions for using outlined in these specification sheets. EVERLIGHT assumes no responsibility for any damage resulting from the use of the product which does not comply with the absolute maximum ratings and the instructions included in these specification sheets.
5. These specification sheets include materials protected under copyright of EVERLIGHT. Reproduction in any form is prohibited without obtaining EVERLIGHT's prior consent.
6. This product is not intended to be used for military, aircraft, automotive, medical, life sustaining or life saving applications or any other application which can result in human injury or death. Please contact authorized Everlight sales agent for special application request.