

SMD ■ MID Power LED

67-21S/KK4C-3HXXXXXXXXX2833Z6/2T/EU



Features

- PLCC-2 package
- Top view white LED
- High luminous intensity output
- Wide viewing angle
- Pb-free
- RoHS compliant
- ANSI Binning

Description

The Everlight 67-21S package has high efficacy, high CRI, low power consumption, wide viewing angle and a compact form factor. These features make this package an ideal LED for all lighting applications.

Applications

- General lighting
- Decorative and Entertainment Lighting
- Indicators
- Illumination
- Switch lights

Product Number Explanation

67-21S / K K 4 C – 3H XX XX XX XX XXXX Z6 / 2T/EU

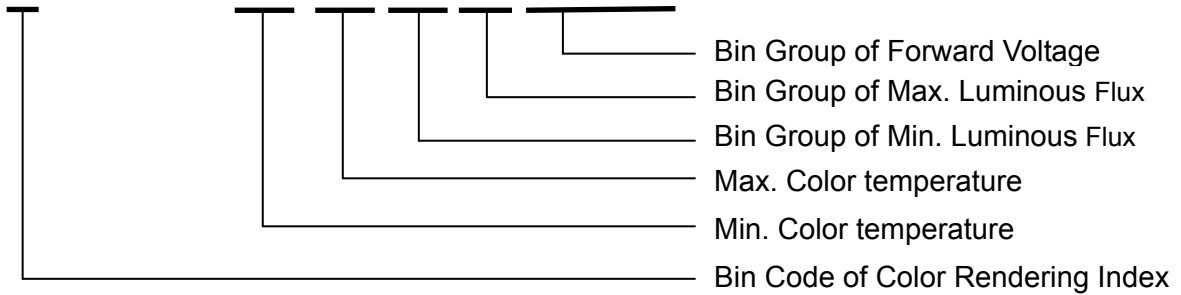

Table of Color Rendering Index

Symbol	Description
M	CRI(Min.) : 60
N	CRI(Min.) : 65
L	CRI(Min.) : 70
Q	CRI(Min.) : 75
K	CRI(Min.) : 80
P	CRI(Min.) : 85
H	CRI(Min.) : 90

Note:
 Tolerance of Color Rendering Index: ±2

Table of Forward Current Index

Symbol	Description
Z6	I _F :60mA

Example:
 67-21S/KK4C-3H3030M42P32833Z6/2T/EU

CRI	80(Min.)
CCT	3000K
Flux	23~39lm
V _F	2.8~3.3V
I _F	60mA

Mass Production List

Product	CRI Min. (1)	CCT(K)	Φ(lm) Min. (2)	Φ(lm) Max. (2)
67-21S/KK4C-3H2727M4N42833Z6/2T/EU	80	2700K	21	33
67-21S/KK4C-3H3030M42P32833Z6/2T/EU	80	3000K	23	39
67-21S/KK4C-3H3535M42P32833Z6/2T/EU	80	3500K	23	39
67-21S/KK4C-3H4040N3P32833Z6/2T/EU	80	4000K	24	39
67-21S/KK4C-3H5050N31P32833Z6/2T/EU	80	5000K	25	39
67-21S/KK4C-3H5757N31P32833Z6/2T/EU	80	5700K	25	39
67-21S/KK4C-3H6060N3P32833Z6/2T/EU	80	6000K	24	39
67-21S/KK4C-3H6565N3P32833Z6/2T/EU	80	6500K	24	39

Notes:

1. Tolerance of Color Rendering Index: ± 3
2. Tolerance of Luminous flux: $\pm 11\%$.

Device Selection Guide

Chip Materials	Emitted Color	Resin Color
InGaN	Cool White Neutral White Warm White	Water Clear

Absolute Maximum Ratings ($T_{\text{Soldering}}=25^{\circ}\text{C}$)

Parameter	Symbol	Rating	Unit
Forward Current	I_F	75	mA
Peak Forward Current (Duty 1/10 @10ms)	I_{FP}	100	mA
Power Dissipation	P_d	250	mW
Operating Temperature	T_{opr}	-40 ~ +85	$^{\circ}\text{C}$
Storage Temperature	T_{stg}	-40 ~ +100	$^{\circ}\text{C}$
Thermal Resistance (Junction / Soldering point)	$R_{th\ J-S}$	50	$^{\circ}\text{C}/\text{W}$
Junction Temperature	T_j	125	$^{\circ}\text{C}$
Soldering Temperature	T_{sol}	Reflow Soldering : 260 $^{\circ}\text{C}$ for 10 sec. Hand Soldering : 350 $^{\circ}\text{C}$ for 3 sec.	

Note:
 The products are sensitive to static electricity and must be carefully taken when handling products

Electro-Optical Characteristics ($T_{\text{Soldering}}=25^{\circ}\text{C}$)

Parameter	Symbol	Min.	Typ.	Max.	Unit	Condition
Luminous Flux ₍₁₎	Φ	21	-----	39	lm	$I_F=60\text{mA}$
Forward Voltage ₍₂₎	V_F	2.8	-----	3.3	V	$I_F=60\text{mA}$
Color Rendering Index ₍₃₎	Ra	80	-----	-----		$I_F=60\text{mA}$
Viewing Angle	$2\theta_{1/2}$	-----	120	-----	deg	$I_F=60\text{mA}$
Reverse Current	I_R	-----	-----	50	μA	$V_R=5\text{V}$

- Notes:
 1. Tolerance of Luminous flux: $\pm 11\%$.
 2. Tolerance of Forward Voltage: $\pm 0.1\text{V}$.
 3. Tolerance of Color Rendering Index: ± 3

Bin Range of Luminous Flux

Bin Code	Min.	Max.	Unit	Condition
M4	21	24	lm	I _F =60mA
M42	23	24		
N3	24	27		
N31	25	27		
N4	27	33		
P3	33	39		

Note:
 Tolerance of Luminous flux: ±11%.

Bin Range of Forward Voltage

Group	Bin Code	Min.	Max.	Unit	Condition
2833	35	2.8	2.9	V	I _F =60mA
	36	2.9	3.0		
	37	3.0	3.1		
	38	3.1	3.2		
	39	3.2	3.3		

Note:
 Tolerance of Forward Voltage: ±0.1V.

The C.I.E. 1931 Chromaticity Diagram

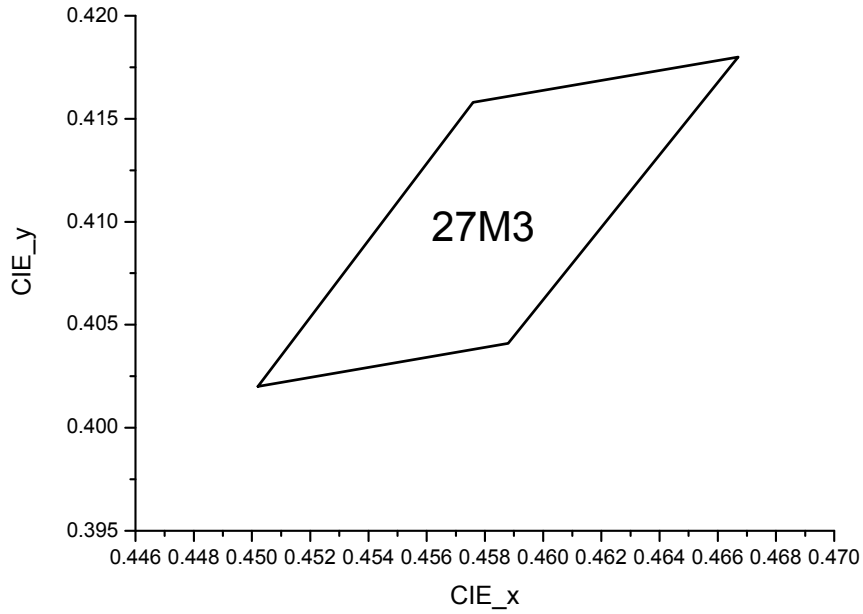

Bin Range of Chromaticity Coordinates

CCT	Bin Code	CIE_x	CIE_y
2700K	27M3	0.4502	0.4020
		0.4576	0.4158
		0.4667	0.4180
		0.4588	0.4041
Reference Range: 2665K~2770K			

The C.I.E. 1931 Chromaticity Diagram

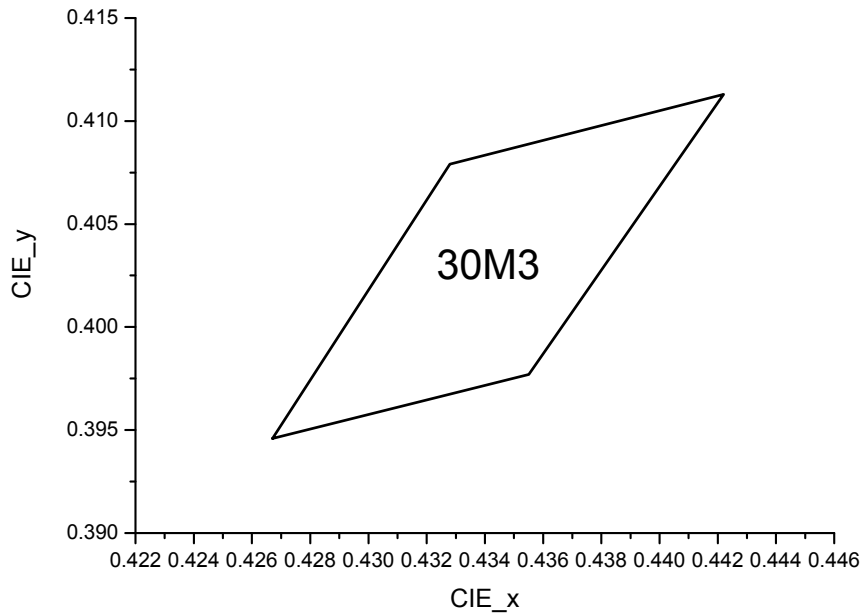

Bin Range of Chromaticity Coordinates

CCT	Bin Code	CIE_x	CIE_y
3000K	30M3	0.4267	0.3946
		0.4328	0.4079
		0.4422	0.4113
		0.4355	0.3977
Reference Range: 2960K~3080K			

The C.I.E. 1931 Chromaticity Diagram

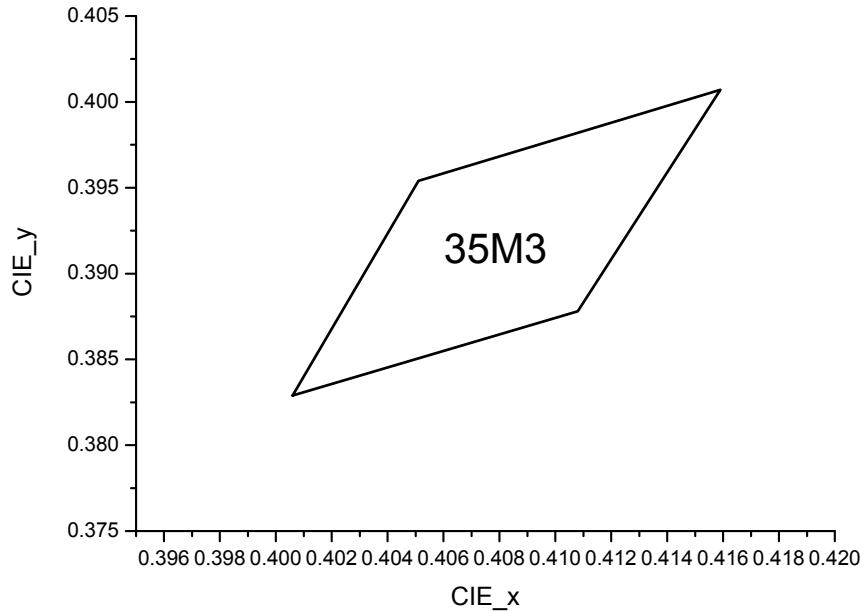

Bin Range of Chromaticity Coordinates

CCT	Bin Code	CIE_x	CIE_y
3500K	35M3	0.4006	0.3829
		0.4051	0.3954
		0.4159	0.4007
		0.4108	0.3878
Reference Range: 3350K~3550K			

The C.I.E. 1931 Chromaticity Diagram

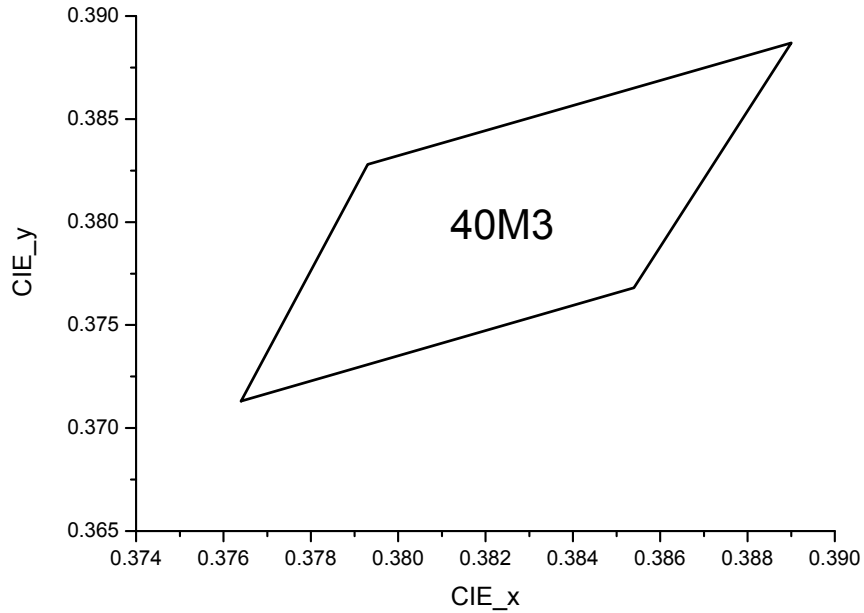

Bin Range of Chromaticity Coordinates

CCT	Bin Code	CIE_x	CIE_y
4000K	40M3	0.3764	0.3713
		0.3793	0.3828
		0.3890	0.3887
		0.3854	0.3768
Reference Range: 3870K~4080K			

The C.I.E. 1931 Chromaticity Diagram

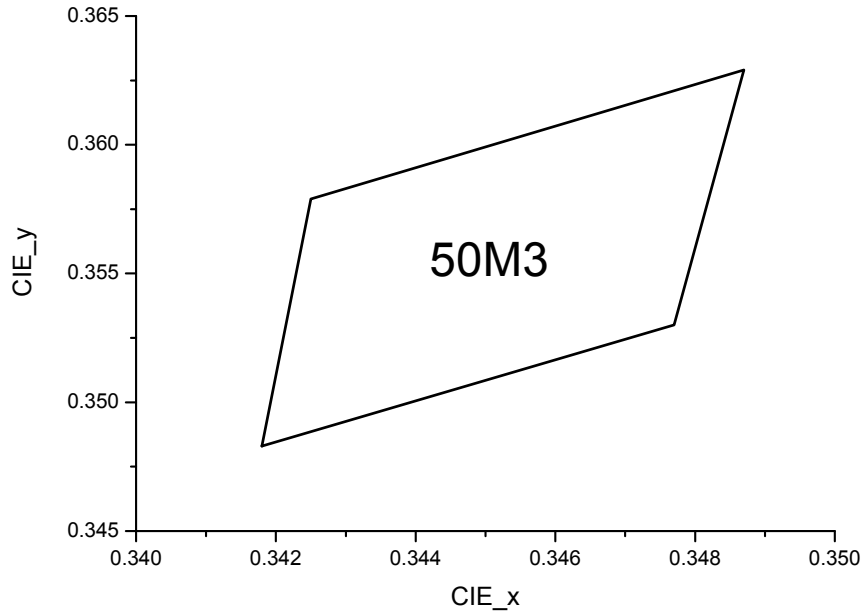

Bin Range of Chromaticity Coordinates

CCT	Bin Code	CIE_x	CIE_y
5000K	50M3	0.3418	0.3483
		0.3425	0.3579
		0.3487	0.3629
		0.3477	0.3530
Reference Range: 4910K~5120K			

The C.I.E. 1931 Chromaticity Diagram

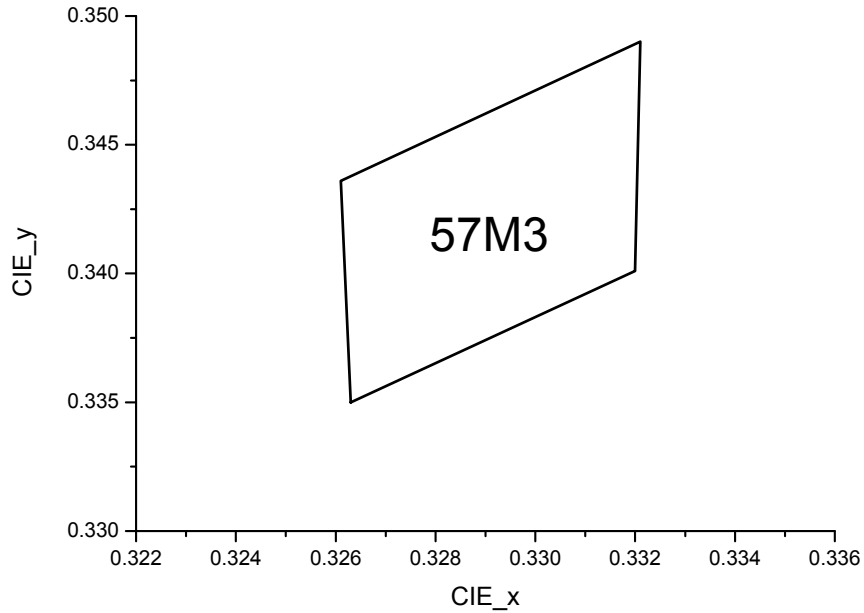

Bin Range of Chromaticity Coordinates

CCT	Bin Code	CIE_x	CIE_y
5700K	57M3	0.3263	0.3350
		0.3261	0.3436
		0.3321	0.3490
		0.3320	0.3401
Reference Range: 5520K~5780K			

The C.I.E. 1931 Chromaticity Diagram

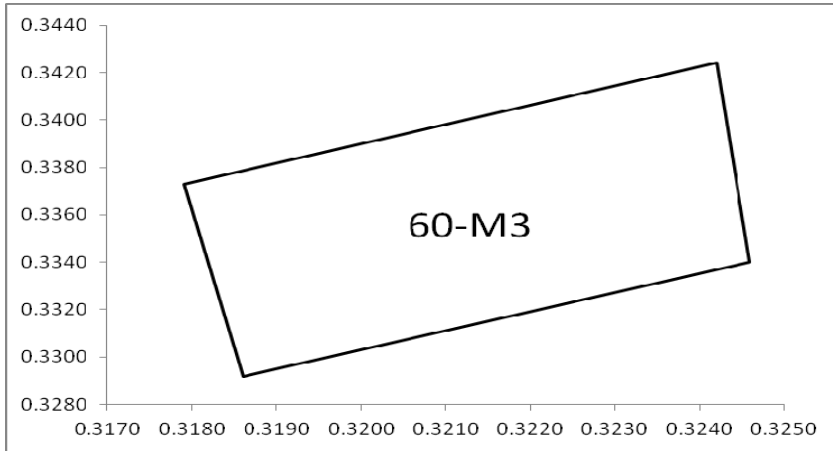

Bin Range of Chromaticity Coordinates

CCT	Bin Code	CIE_x	CIE_y
6000K	60M3	0.3242	0.3424
		0.3179	0.3373
		0.3186	0.3292
		0.3246	0.3340
Reference Range: 5860K~6190K			

The C.I.E. 1931 Chromaticity Diagram

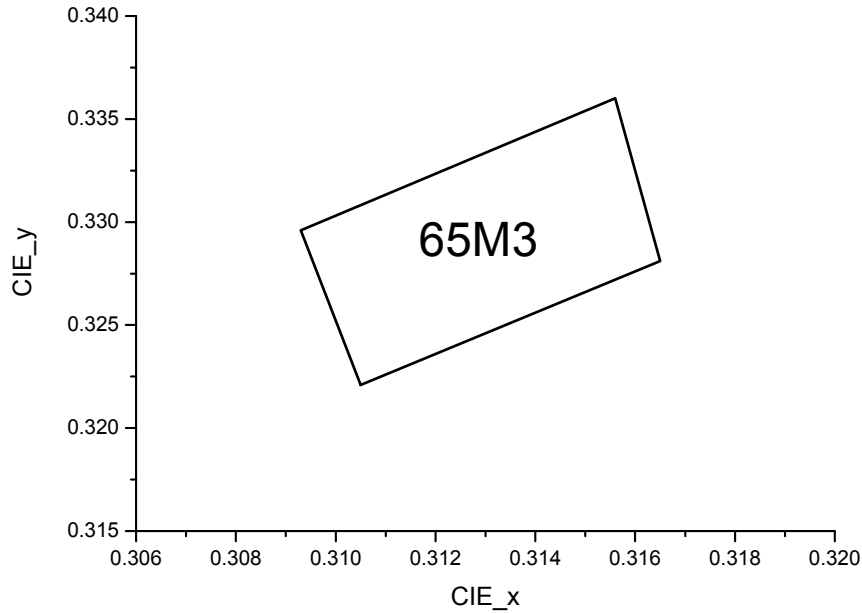

Bin Range of Chromaticity Coordinates

CCT	Bin Code	CIE_x	CIE_y
6500K	65M3	0.3105	0.3221
		0.3093	0.3296
		0.3156	0.3360
		0.3165	0.3281
Reference Range: 6300K~6690K			

Notes:

1. The value is based on driving current by 60mA.
2. Tolerance of Chromaticity Coordinates: ± 0.01 .

Spectrum Distribution

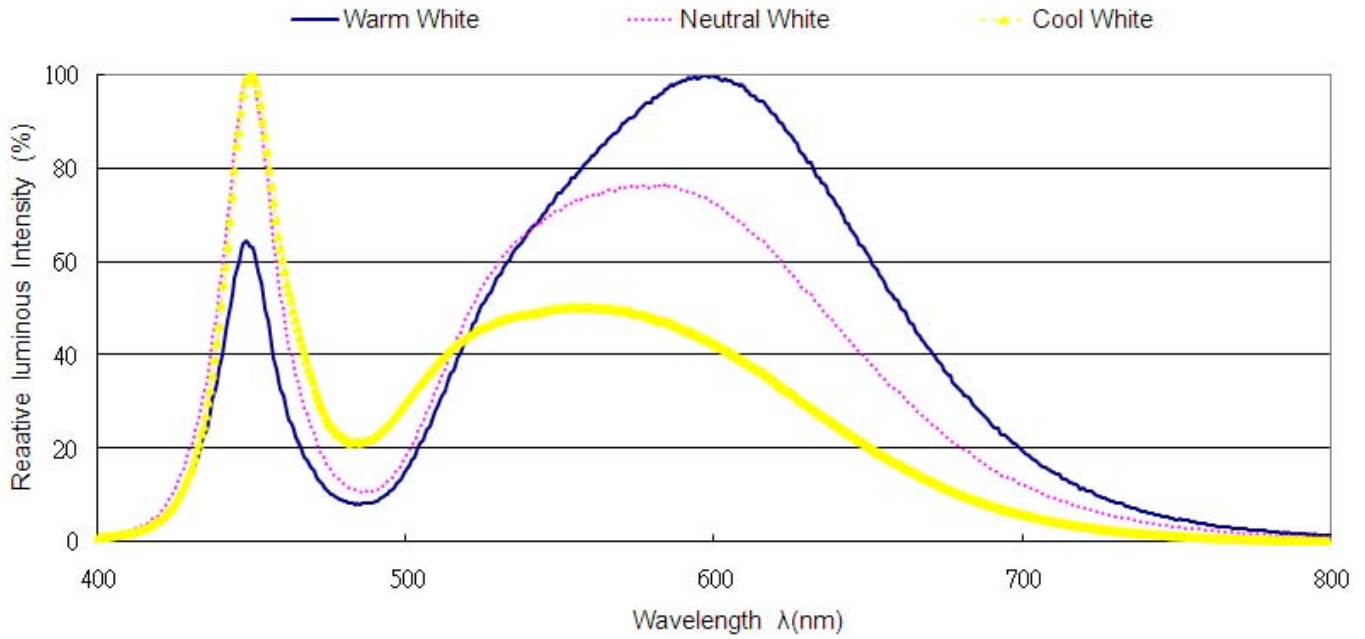

Typical Electro-Optical Characteristics Curves

Fig.1 – Forward Voltage Shift vs. Junction Temperature

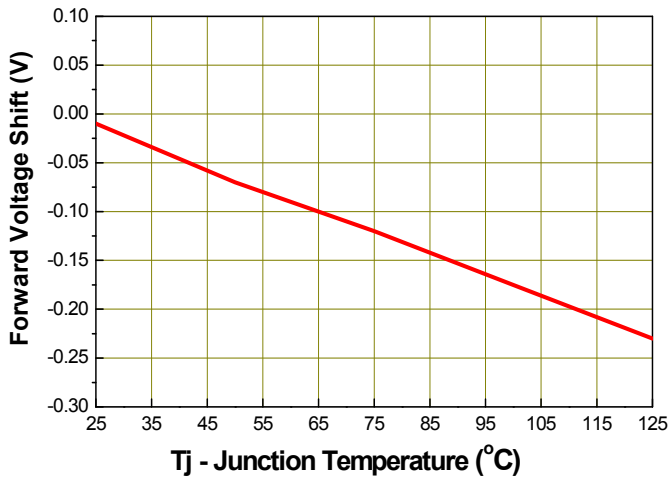
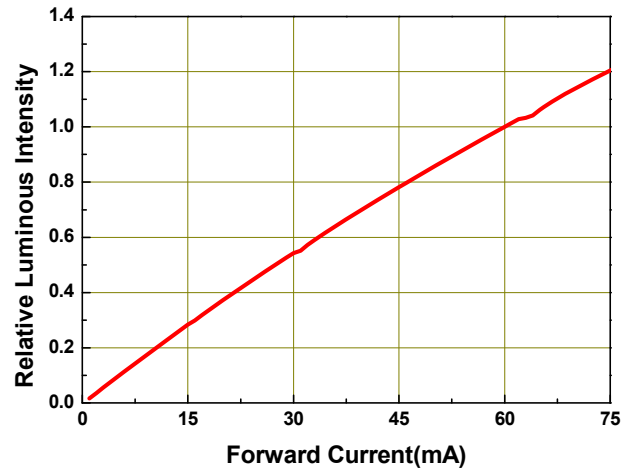

Fig.2 - Relative Luminous Intensity vs. Forward Current



Typical Electro-Optical Characteristics Curves

Fig.3 - Relative Luminous Intensity vs. Junction Temperature

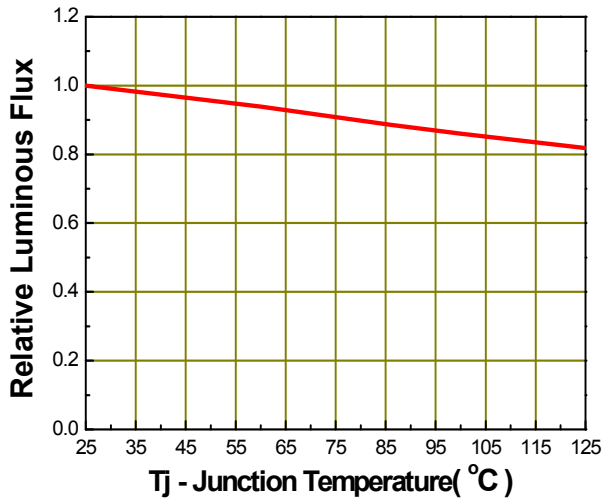

Fig.4 - Forward Current vs. Forward Voltage

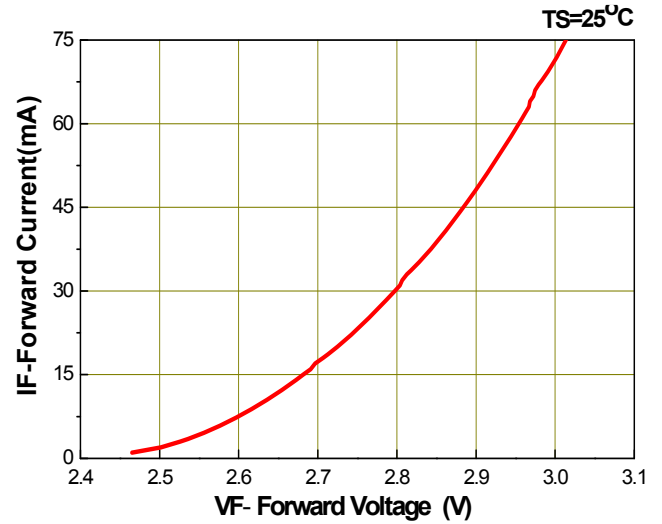

Fig.5 – Max. Driving Forward Current vs. Soldering Temperature

R_{th j-s}=50 °C/W

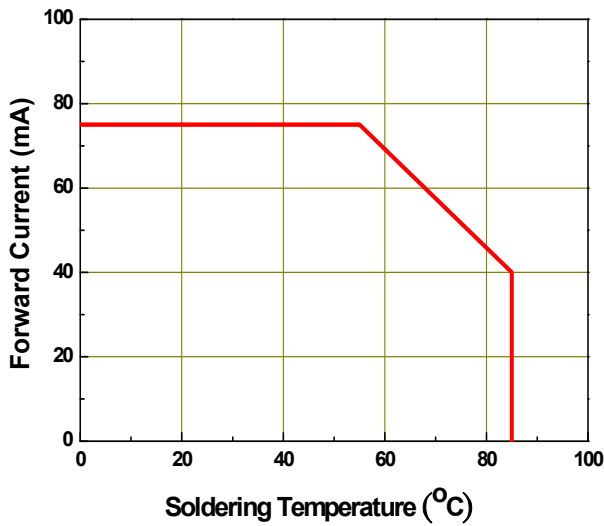
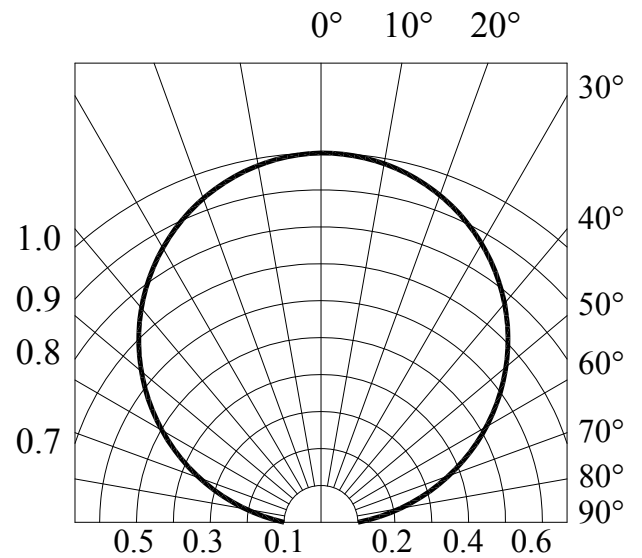
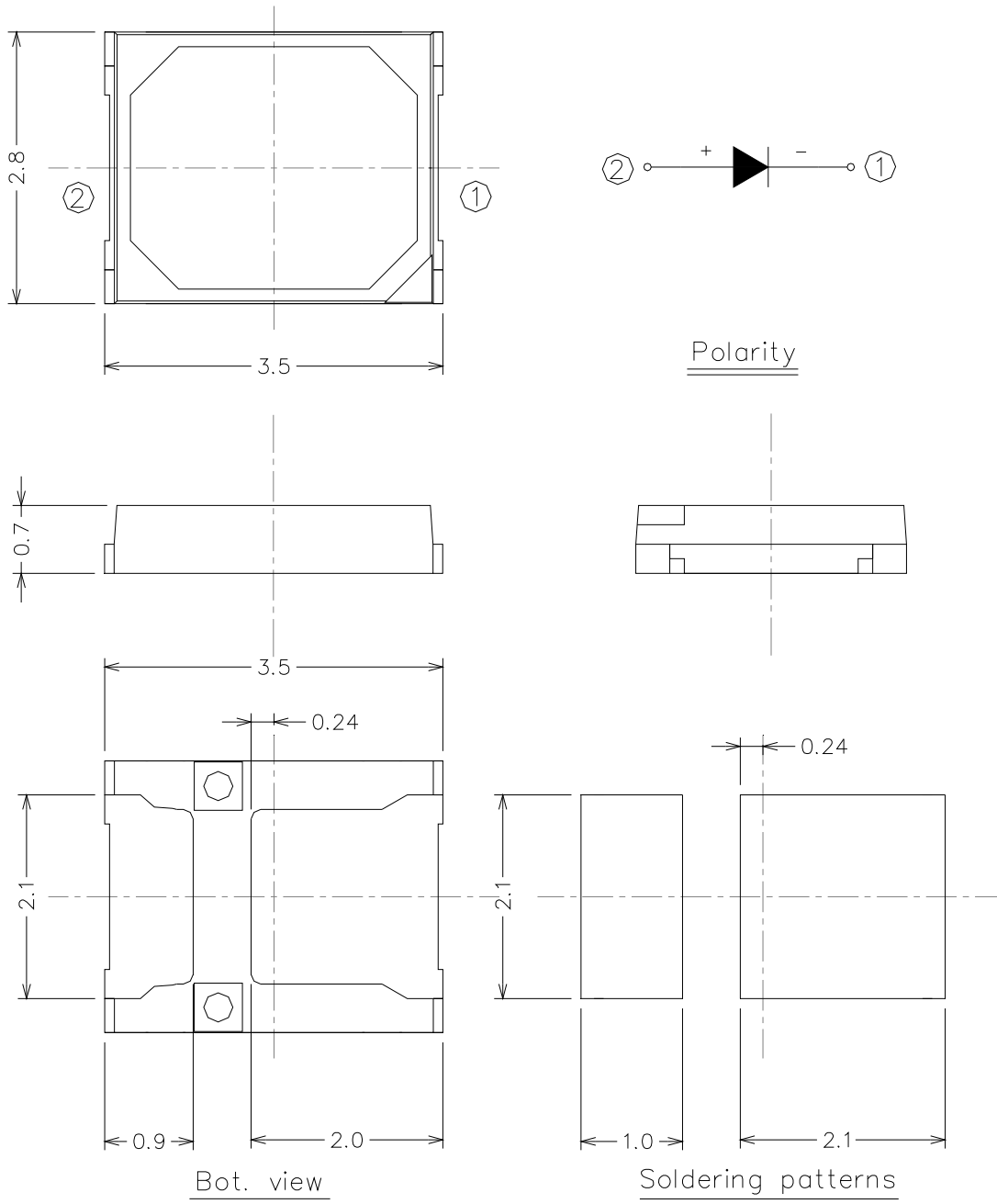

Fig.6 – Radiation Diagram



Package Dimension



Note:
Tolerance unless mentioned is ± 0.15 mm; Unit = mm

Moisture Resistant Packing Materials

Label Explanation

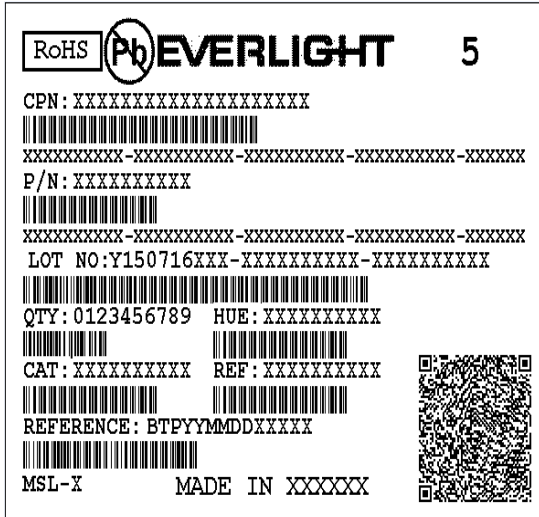

- CPN: Customer's Product Number
- P/N: Product Number
- QTY: Packing Quantity
- CAT: Luminous Intensity Rank
- HUE: Dom. Wavelength Rank
- REF: Forward Voltage Rank
- LOT No: Lot Number

Reel Dimensions

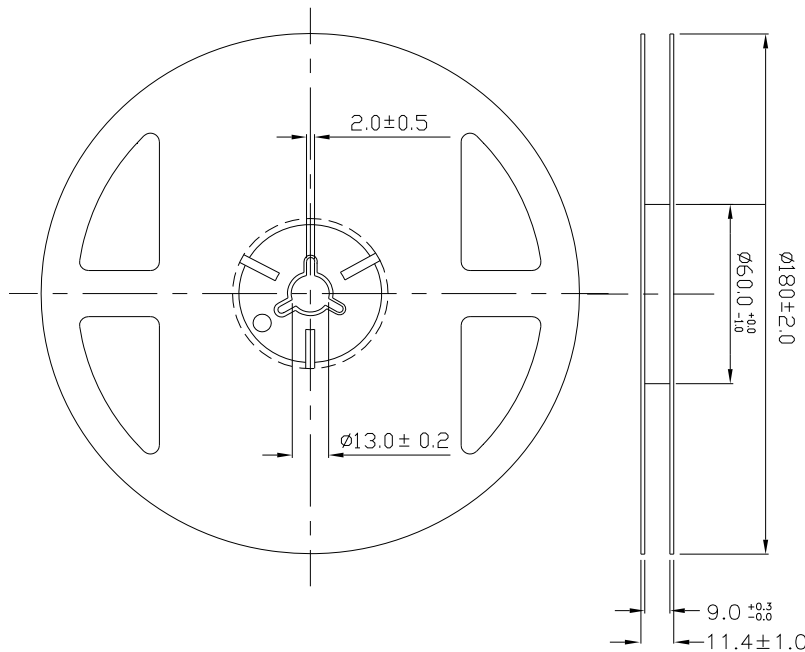

Note:
 Tolerances unless mentioned ±0.1mm. Unit = mm

Carrier Tape Dimensions: Loaded Quantity 4000 pcs Per Reel

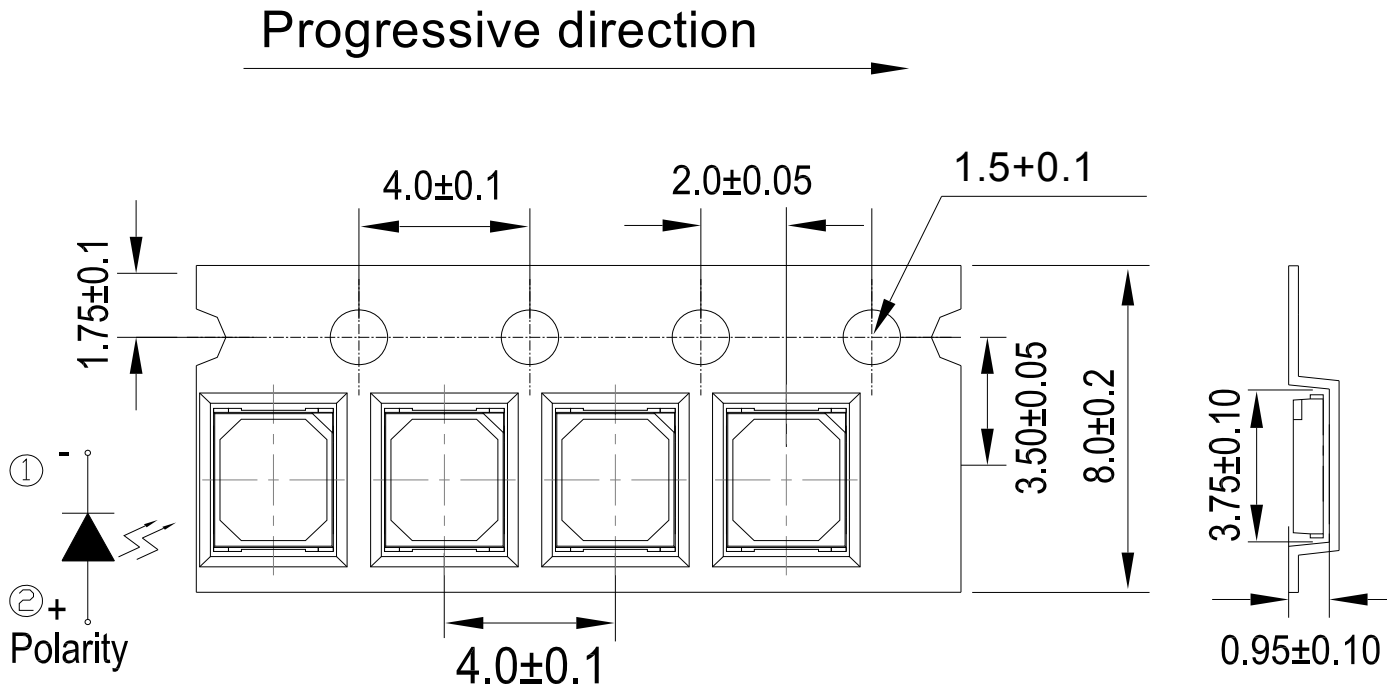

Note:
 1. Tolerance unless mentioned is ± 0.1 mm; Unit = mm

Moisture Resistant Packing Process

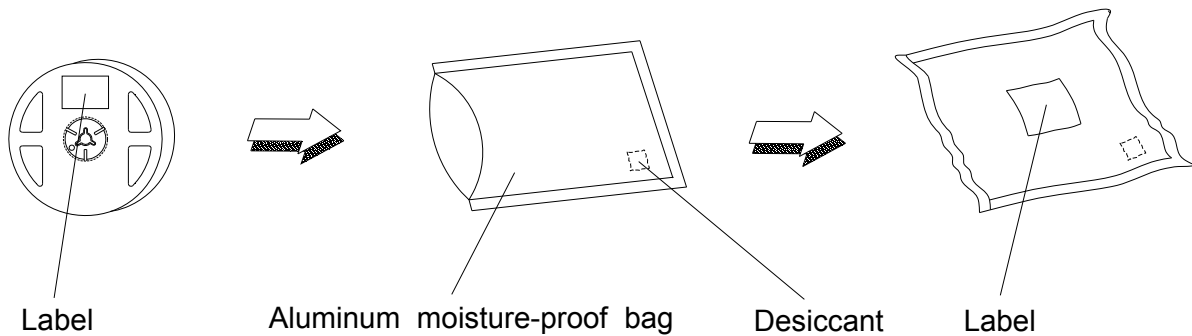

Reliability Test Items and Conditions

The reliability of products shall be satisfied with items listed below.
Confidence level : 90%
LTPD : 10%

No.	Items	Test Condition	Test Hours/Cycles	Sample Size	Ac/Re
1	Reflow Soldering	Temp. : 260°C/10sec.	6 Min.	22 PCS.	0/1
2	Thermal Shock	H : +100°C 20min ∩ 10 sec L : -10°C 20min	200 Cycles	22 PCS.	0/1
3	Temperature Cycle	H : +100°C 30min ∩ 5 min L : -40°C 30min	200 Cycles	22 PCS.	0/1
4	High Temperature/Humidity Reverse Bias	Ta=85°C,85%RH	1000 Hrs.	22 PCS.	0/1
5	High Temperature/Humidity Operation	Ta=85°C,85%RH, I _F = 40 mA	1000 Hrs.	22 PCS.	0/1
6	Low Temperature Storage	Ta=-40°C	1000 Hrs.	22 PCS.	0/1
7	High Temperature Storage	Ta=85°C	1000 Hrs.	22 PCS.	0/1
8	Low Temperature Operation Life	Ta=-40°C, I _F = 75 mA	1000 Hrs.	22 PCS.	0/1
9	High Temperature Operation/ Life#1	Ta=25°C, I _F = 75 mA	1000 Hrs.	22 PCS.	0/1
10	High Temperature Operation/ Life#2	Ta=55°C, I _F =75 mA	1000 Hrs.	22 PCS.	0/1
11	High Temperature Operation/ Life#3	Ta=85°C, I _F = 40 mA	1000 Hrs.	22 PCS.	0/1

Precautions for Use

1. Over-current-proof
Customer must apply resistors for protection; otherwise slight voltage shift will cause big current change (Burn out will happen).
2. Storage
 - 2.1 Do not open moisture proof bag before the products are ready to use.
 - 2.2 Before opening the package: The LEDs should be kept at 30°C or less and 90%RH or less.
 - 2.3 After opening the package: The LED's floor life is 168 Hrs under 30°C or less and 60% RH or less. If unused LEDs remain, it should be stored in moisture proof packages.
 - 2.4 If the moisture absorbent material (silica gel) has faded away or the LEDs have exceeded the storage time, baking treatment should be performed using the following conditions.
Baking treatment: 60±5°C for 24 hours.
3. Soldering Condition
 - 3.1 Pb-free solder temperature profile

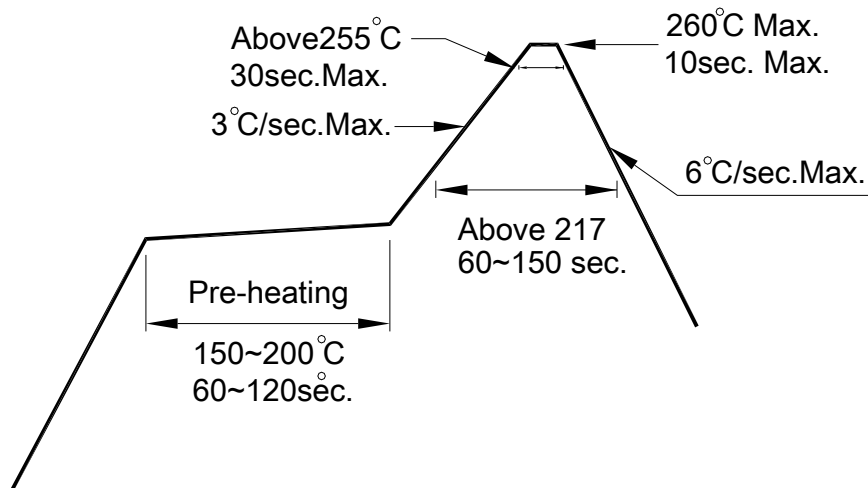

- 3.2 Reflow soldering should not be done more than two times.
- 3.3 When soldering, do not put stress on the LEDs during heating.
- 3.4 After soldering, do not warp the circuit board.

4. Soldering Iron

Each terminal is to go to the tip of soldering iron temperature less than 350°C for 3 seconds within once in less than the soldering iron capacity 25W. Leave two seconds and more intervals, and do soldering of each terminal. Be careful because the damage of the product is often started at the time of the hand solder.

5. Repairing

Repair should not be done after the LEDs have been soldered. When repairing is unavoidable, a double-head soldering iron should be used (as below figure). It should be confirmed beforehand whether the characteristics of the LEDs will or will not be damaged by repairing.

